



Battery Backup Sump Pump System

Instruction Manual & Safety Warnings



		Battery Backup Sump Pump System	
Press and hold for 1 second to reset pump alarm		Press and hold for 5 seconds to silence any alarm for 24 hours	
Warning	What to do		
● Battery	Terminals corroded or battery defective Clean terminals or replace battery		
● Fuse	Replace with 20 amp auto fuse If fuse blows again, replace pump		
● Water	Add distilled water to battery		
● Pump	Pump was activated Check main pump for failure		
● Power	Check the circuit breaker Make sure charger is plugged into wall & controller If power is on, replace the charger	● Charging	● System Operating
Computer-Controlled Automatic Charging & Monitoring System			

Table of Contents

Important Safety Warnings and Instructions

Electrical Precautions	1
Battery Preparation	1
Battery Precautions	1

Introduction

Items Included in System	2
Additional Items Needed	2
System Specifications	2
Replacement Parts List	2

Pump & Pipe

Installation Instructions

Installation Options	3
Direct Discharge to Outside	4
Connection to Existing Discharge	5
Direct Discharge for Narrow Sumps	6
Connection to Existing Discharge for Narrow Sumps	7

Battery Instructions

Preparation of the Battery	8,9
----------------------------	-----

Control Unit Connections

Positioning the Float Switch	9
Connecting the Pump	9
Installing the Battery Fluid Sensor	10
Connecting the Battery	10
Connecting the Charger	10

Understanding the Warning Lights and Alarms

Silencing the Alarm	
During an Emergency	11
Battery Alarm	11
Cleaning Battery Terminals	11,12
Replacing the Battery	12
Fuse Alarm	13
Water Alarm	13
Pump Alarm	14
Replacing the Pump	14
Power Alarm	15
Charging	15
System Operating	15

Testing the System

Test-Reset-Silence Button	15
Testing the Float Switch	15

Parts & Service Information

Technical Support	15
-------------------	----

Troubleshooting Guide

	16
--	----

Warranty

	17
--	----

Other Products

	18
--	----

IMPORTANT: Even if you have the Basement Watchdog Special Backup Sump Pump System installed by someone else, you must read and follow the safety information contained in this manual. Failure to do so could result in property damage, serious injury, or death.

Important Safety Warnings & Instructions

SAVE THESE INSTRUCTIONS. This manual contains important SAFETY WARNINGS and OPERATING INSTRUCTIONS for the Basement Watchdog Special battery backup sump pump system. You will need to refer to it before attempting any installation or maintenance. ALWAYS keep these instructions with the unit so that they will be easily accessible.

Failure to read and follow these warnings and instructions could result in property damage, serious injury, or death. It is important to read this manual, even if you did not install the Basement Watchdog backup sump pump system, since this manual contains safety information regarding the use and maintenance of this product. **DO NOT DISCARD THIS MANUAL.**

ELECTRICAL PRECAUTIONS

⚠ DANGER

Risk of electrical and fire hazard. May result in death, serious injury, shock or burns.

To help reduce these risks, observe the following precautions:

- **DO NOT** walk on wet areas of the basement until all power has been turned off. If the main power supply is in a wet basement, call an electrician.
- **NEVER** handle the control unit with wet hands or while standing on a wet surface.
- **ALWAYS** unplug the control unit and disconnect the cables from the battery before attempting any maintenance or cleaning.
- **ALWAYS** unplug the main pump when installing or servicing the backup pump or float switch to avoid electric shock.
- **DO NOT** expose the control unit to rain or snow.
- **DO NOT** pull the cord when disconnecting the control unit. Pull the plug.

- **DO NOT** use an extension cord unless absolutely necessary. If an extension cord must be used, be sure the plug has the same configuration as the plug on the control unit.
- **DO NOT** use an attachment not recommended or sold by the manufacturer. It may result in a risk of fire or injury from an electrical shock.
- **DO NOT** operate the control unit if it has received a sharp blow, been dropped, or otherwise damaged in any way.
- **DO NOT** disassemble the control unit.

When service is required, contact Glentronics technical support at **800-991-0466, option #3**, or send an e-mail to service@glentronics.com. Return the control unit to the manufacturer for any repairs at the following address:

Glentronics, Inc.
645 Heathrow Drive
Lincolnshire, IL 60069-4205

BATTERY PREPARATION

⚠ WARNING / POISON

Sulfuric acid can cause blindness or severe burns. Avoid contact with skin, eyes, or clothing. In the event of an accident, flush with water and call a physician immediately. KEEP OUT OF REACH OF CHILDREN.

To help reduce these risks, observe the following precautions:

- Someone should be within range of your voice or close enough to come to your aid when you work near a lead-acid battery.
- Have plenty of fresh water and soap nearby in case battery acid contacts skin, clothing or eyes.
- Wear eye and clothing protection and avoid touching your eyes while working with battery acid or working near the battery.
- If battery acid contacts skin or clothing, wash immediately with soap and water. If acid enters eye, immediately flood eye with running cold water for at least 15 minutes and get professional medical attention.

- Battery posts and terminals contain lead and lead compounds, chemicals known to the State of California to cause cancer and reproductive harm. Wash hands after handling.

BATTERY PRECAUTIONS

⚠ DANGER

Explosive gases could cause serious injury or death. Cigarettes, flames or sparks could cause battery to explode in enclosed spaces. Charge in a well-ventilated area. Always shield eyes and face from battery. Keep vent caps tight and level.

To help reduce these risks, observe the following precautions:

- **NEVER** smoke or allow a spark or flame in the vicinity of the battery.
- Use the Basement Watchdog control unit for charging a LEAD-ACID battery only. **DO NOT** use the control unit for charging dry-cell batteries that are most commonly used with home appliances.
- Be sure the area around the battery is well-ventilated.
- When cleaning or adding water to the battery, first fan the top of the battery with a piece of cardboard (or another non-metallic material) to blow away any hydrogen or oxygen gas that may have been emitted from the battery.
- **DO NOT** drop a metal tool onto the battery. It might spark or short-circuit the battery and cause an explosion.
- Remove personal metal items such as rings, bracelets, watches, etc. when working with a lead-acid battery. A short circuit through one of these items can melt it, causing a severe burn.
- **ALWAYS** remove the charger from the electrical outlet before connecting or disconnecting the battery cables. Check the polarity of the battery posts. The POSITIVE (+) battery post usually has a larger diameter than the NEGATIVE (-) post.

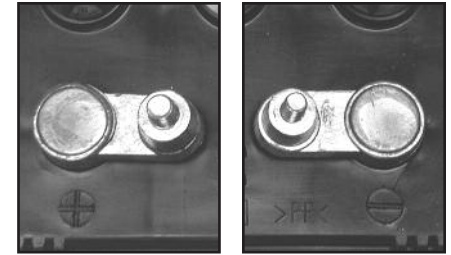

POSITIVE POST HAS LARGER DIAMETER

NEGATIVE POST HAS SMALLER DIAMETER

- When connecting the battery cables, first connect the small ring on the end of the BLACK wire to the NEGATIVE (-) post of the battery, and then connect the large ring on the end of the RED wire to the POSITIVE (+) post of the battery.

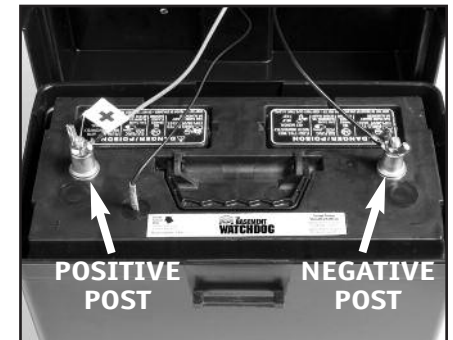

⚠ DANGER

Do not use this system to pump flammable or explosive fluids such as gasoline, fuel oil, kerosene, etc.

Introduction

The Basement Watchdog Special backup sump pump system is battery-operated. It is designed as an emergency backup system to support your main AC sump pump, and it will automatically begin pumping any time the float switch is activated by rising water. Should any malfunction or emergency occur that involves the sump pump, the battery, or the AC power, the Basement Watchdog system will sound an alarm. A light on the display panel of the control unit will indicate the cause of the alarm and the corrective action.

For added reliability, the float switch has, not one, but two floats. Should one float fail to operate, the second float automatically activates the pump.

The Basement Watchdog Special Sump Pump System includes:

- A control unit with a dual float switch, a battery fluid level sensor, battery cables, and a 20 amp fuse
- A pump with a 1½" PVC pipe adapter
- A plastic wire tie for mounting the float switch
- A battery box
- A battery charger
- A battery cap with a hole to accommodate the fluid sensor

You will also need to supply:

- A Basement Watchdog 7.5 Hour Standby Battery
 - DO NOT** use an automotive battery with this system
 - DO NOT** use a maintenance-free or sealed battery with this system
 - DO NOT** use a Basement Watchdog Emergency battery with this system. It will not run the pump as long as the 7.5 hour battery
- 1½" rigid PVC pipe and fittings
- PVC primer and cement
- A union with hose clamps or a "Y" connector and two (2) check valves, depending on the installation method you use
- A surge protector (recommended)
- Six (6) quarts of 1.265 specific gravity battery acid

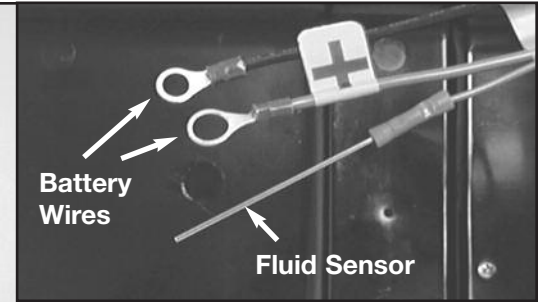

For narrow sump pits you will need some additional parts:

- An "L" bracket at least six (6) inches long (preferably one that will not rust)
- Two (2) stainless steel hose clamps
- One (1) stainless steel screw (#8-32 x 3/4"), a matching washer & nut

Use of a Basement Watchdog Klunkless Check Valve™ will provide quieter operation. (See page 18 for more information.)

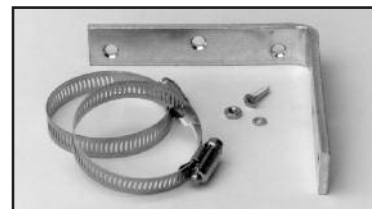

Replacement Part Numbers

Pump1011002
Float switch assembly1020009
Fluid sensor assembly1014001
Pipe adapter1120002
Charger1015001
Battery box1113003
Battery cap with hole1125000

Call 800-991-0466, option #3 to order parts.

System Specifications

Power supply requirements115 volts AC
Pumping capacity2500 GPH @ 0'
Pumping capacity1730 GPH @ 10'
Pump dimensions w/elbow7½" H x 9"W
Pump housing & strainernon-corrosive, will not rust
Pumpcan run dry for short periods of time; can be used in sumps with water softener
Float switchindependent, can be set at any level

Pump & Pipe Installation Instructions

There are two basic methods that can be used to install the pump, a direct discharge to the outside of the building, or a connection to an existing discharge pipe. The same two options apply in very narrow sump pits where the backup pump must be mounted above the main pump.

Whenever possible, install your Basement Watchdog backup pump with a direct discharge to the outdoors. By using this method, there will always be an outlet for the water from the sump. During times of very heavy rain, many storm sewers fill up. If your pump is trying to discharge water into a full sewer, there is nowhere for the water to go. By discharging directly outdoors, there is always an outlet for the water that is pumped out of the sump. For this method, you will need to drill a hole through a floor joist or the foundation from the basement to the outside of the house.

If the direct discharge method is not possible or convenient, the Basement Watchdog pump can be connected to the same line as your main AC sump pump by installing a "Y" connector and two (2) check valves.

In most cases, the backup pump will fit next to the main AC pump in the sump pit. In very narrow pits, the backup pump can be mounted above the main AC pump. Try to fit the backup pump on the floor of the sump first. Make sure there is enough room so that the backup pump and the main pump do not touch each other.

Select the installation method that will best suit your needs from the diagrams at the right. Full instructions for each installation method are provided on the following pages.

Installation will take a couple hours.

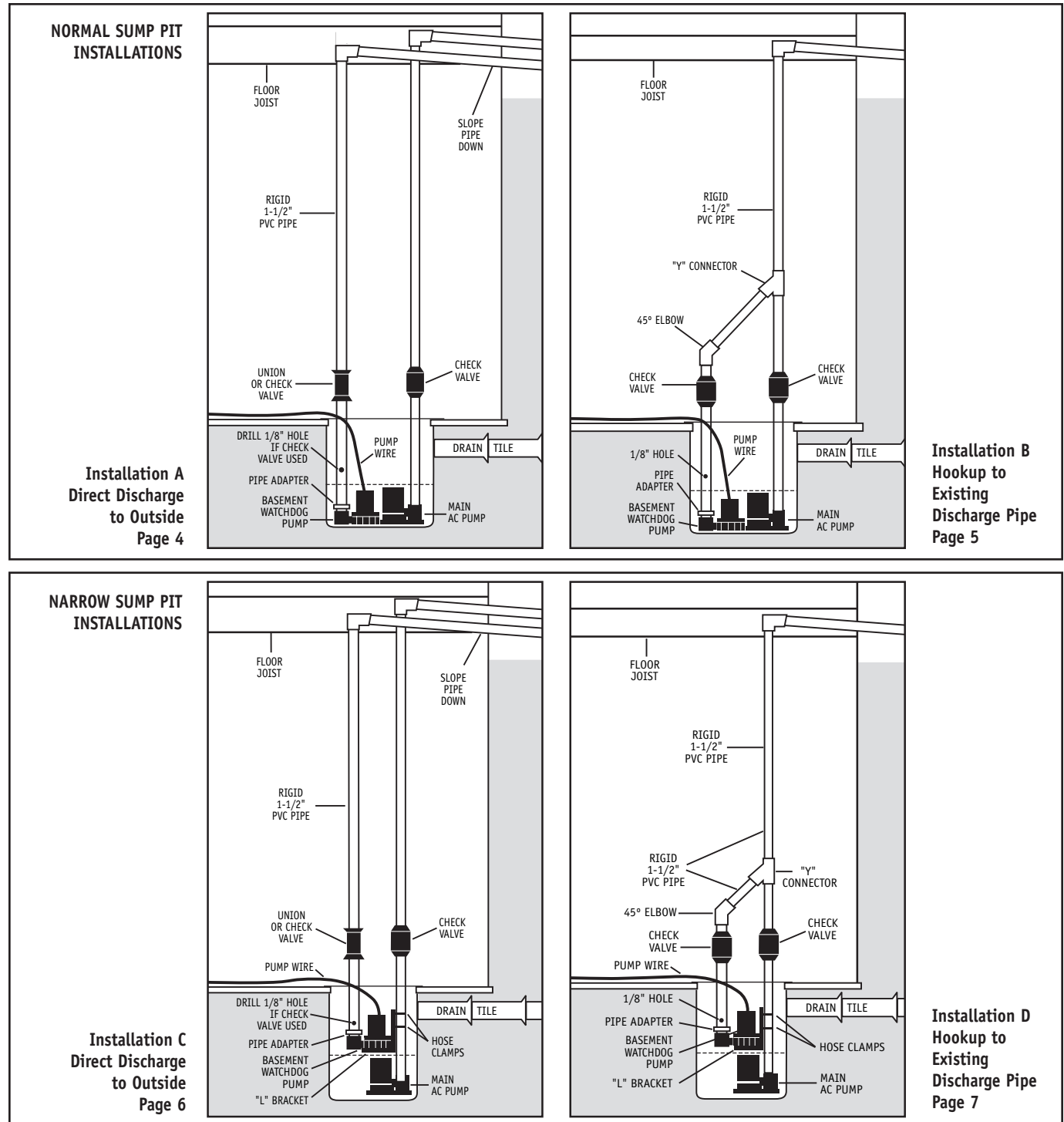

Pump & Pipe Installation Instructions

**INSTALLATION A:
DIRECT DISCHARGE TO THE OUTSIDE OF THE
BUILDING (Diagram A)**

⚠ DANGER

Unplug the main AC pump when installing the backup pump to avoid electric shock. Failure to do so could cause serious injury or death.

1. Cut a piece of 1½" rigid PVC pipe long enough to reach from the bottom of the sump pit to one (1) foot above the floor. Prime and cement it to the 1½" pipe adapter, then screw the adapter into the pump.
2. Secure the pump wire so that the plug on the end will not fall into the sump. Attach the wire to the pipe with a piece of tape.
3. Place the pump with the PVC pipe attachment on the bottom of the sump floor next to the main AC pump. The pumps should not touch each other. Do not mount

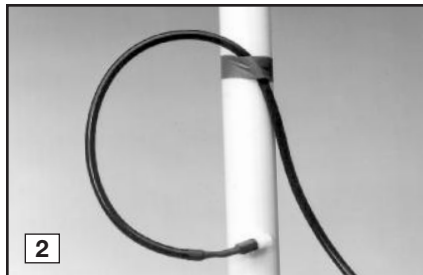

the pump to any existing pipes; it should be placed on the floor of the sump. A brick may be placed under the pump if there are rocks or other debris on the sump floor that may clog the pump.

4. Attach a union or a check valve to the top of the 1½" pipe. This will allow the pump to be removed easily, should the need arise.

The path of the rest of the pipe and the details of each installation will vary. Using sound plumbing practices, try to route the discharge pipe to an exterior wall via the shortest path with the fewest turns. More turns will reduce the pumping capacity. The pipe section exiting the building should be on a downward slope so that the water in the pipe will exit outside instead of returning to the sump pit. Be sure to seal the hole in the wall where the pipe exits, and prime and cement or clamp all connections securely to prevent leaking. (No check valve is needed with this method of installation as long as you use less than 20 feet of pipe.)

CAUTION

If you use more than a total of 20 feet of pipe in the installation, install a check valve

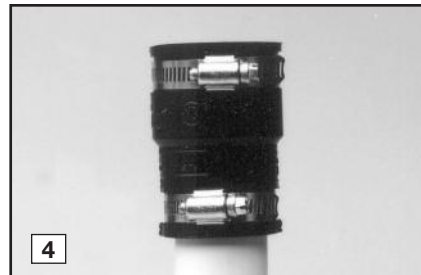

in place of the union. Make sure it is installed with the arrow pointing up, or it will not prevent the backflow of water. When a check valve is used, a 1/8" hole must be drilled in the PVC pipe above the Basement Watchdog pump. Drill the hole at a 45° angle toward the bottom of the sump to avoid splashing water outside the sump pit. Make sure the hole is above the water line and below the check valve. If a hole is not drilled above the pump, an air lock may prevent the pump from operating, and the basement will flood.

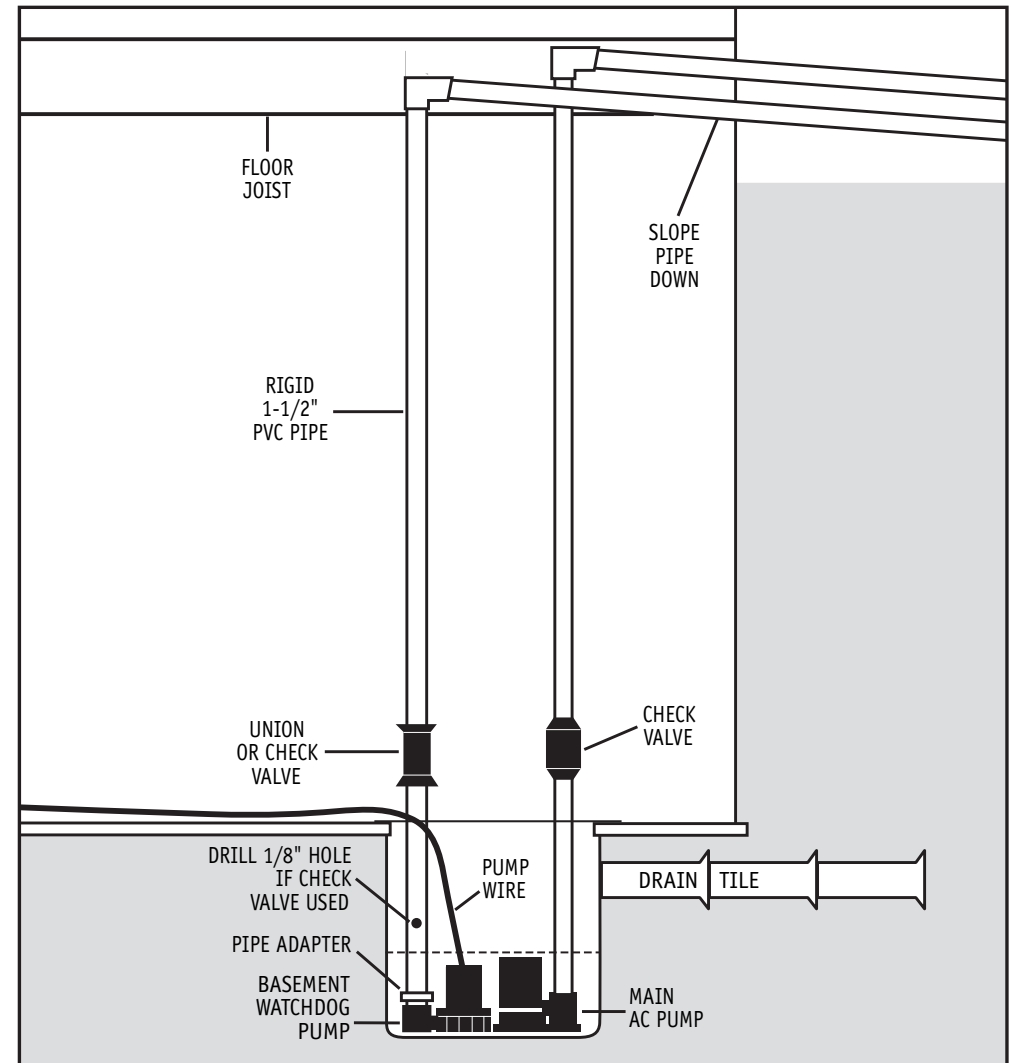
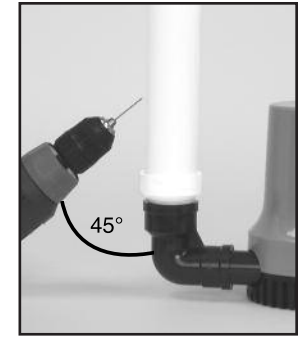
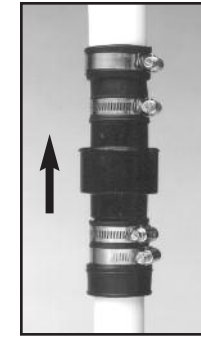

Diagram A

Pump & Pipe Installation Instructions

INSTALLATION B: CONNECTION TO AN EXISTING DISCHARGE PIPE (Diagram B)

Depending on your installation requirements, PVC pipe lengths will vary. Cut the pipes and assemble them as shown in photo #7. *Do not cement them together until you are sure they are cut to the correct lengths.* It is important to keep the discharge pipes on both pumps parallel to each other, so that the pumps remain flat on the floor of the sump. More detailed instructions follow.

⚠ DANGER

Unplug the main AC pump when installing the backup pump to avoid electric shock. Failure to do so could cause serious injury or death.

1. Cut a piece of 1½" rigid PVC pipe long enough to reach from the bottom of the sump pit to one (1) foot above the floor. Prime and cement it to the 1½" pipe adapter, then screw the adapter into the pump.
2. Install a check valve on the top of the PVC pipe attached to the Basement Watchdog pump. Make sure it is installed with the arrow pointing up or it will not prevent the backflow of water.

CAUTION

3. When a check valve is used, a 1/8" hole

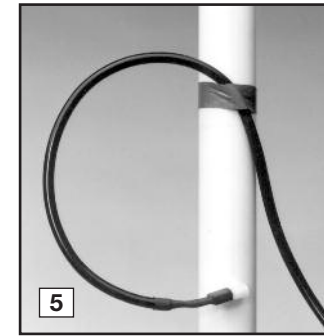
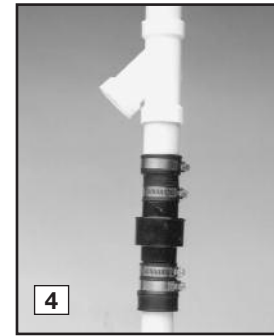
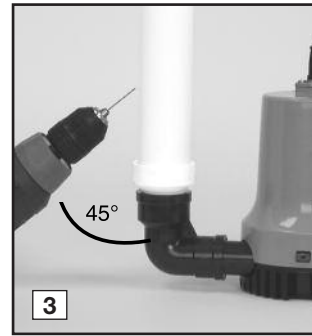
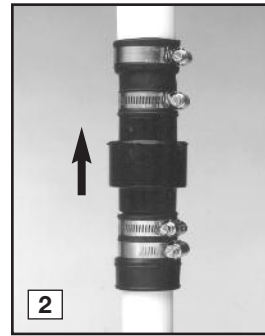

must be drilled in the PVC pipe above the Basement Watchdog pump. Make sure it is above the water line and below the check valve. Drill the hole at a 45° angle toward the bottom of the sump to avoid splashing water outside the sump pit. If a 1/8" hole is not drilled in the pipe above the pump, an air lock may prevent the pump from operating, and the basement will flood.

4. If there is no check valve on the discharge pipe of the main AC pump, one must be installed at this time. Cut the discharge pipe approximately one (1) foot above the floor. Install a check valve on the top of the pipe and tighten the bottom hose clamp. Now prime and cement a small piece of 1½" PVC pipe to the bottom of a "Y" connector. Prime and cement the top of the "Y" assembly to the discharge pipe with the "Y" extension facing down toward the backup pump. Now connect the bottom of the assembly to the check valve and tighten the hose clamp.

5. Secure the pump wire so that the plug on the end will not fall into the sump. Attach the wire to the pipe with a piece of tape.

6. Place the pump with the PVC pipe attachment on the bottom of the sump floor next to the main AC pump. *The pumps should not touch each other.* Do not mount the pump to any existing pipes; it should be placed on the floor of the sump. A brick may be placed under the pump if there are rocks or other debris on the sump floor that may clog the pump.



7. Connect a piece of 1½" PVC pipe above the check valve of the Basement Watchdog pump, and attach a 45° elbow to that pipe. Extend another piece of pipe to reach from the 45° elbow to the "Y" connector on the other pipe.

8. Prime and cement all pipe connections securely to prevent leaking, and tighten all the hose clamps.

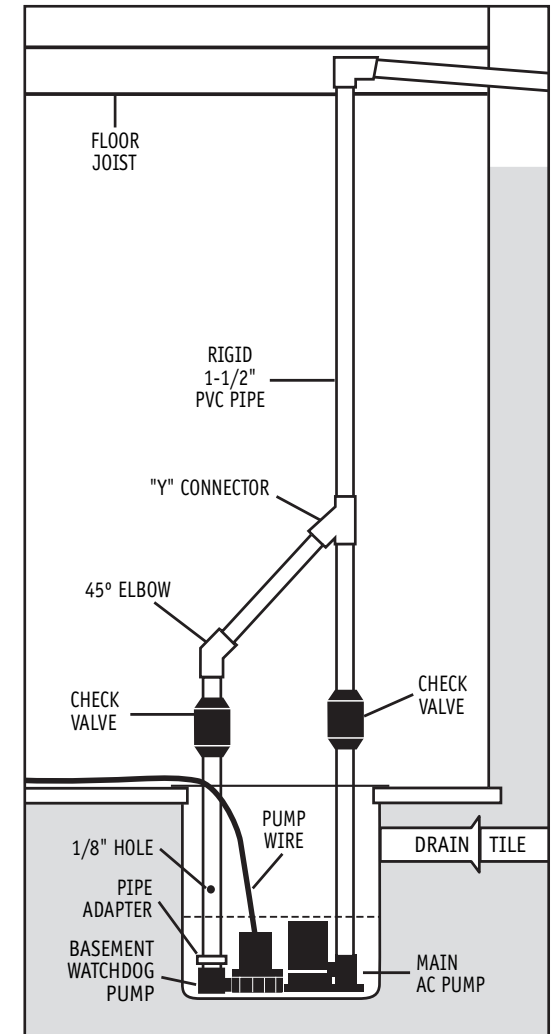

Diagram B

Pump & Pipe Installation Instructions

**INSTALLATION C:
DIRECT DISCHARGE TO THE OUTSIDE OF THE
BUILDING FOR NARROW SUMP PITS
(Diagram C)**

⚠ DANGER

Unplug the main AC pump when installing the backup pump to avoid electric shock. Failure to do so could cause serious injury or death.

1. Attach an "L" bracket to the discharge pipe of the main AC pump with two (2) stainless steel hose clamps. Position the bracket so the bottom of the "L" is just above the top of the main pump, and out of the way of any float switch on the main pump.
2. (a) Remove the black bottom strainer of the pump by pressing in the two tabs on the strainer and pushing down. There are holes suitable for mounting on the bottom of the strainer. (b) Using the #8-32 x 3/4" stainless steel screw, washer and nut, attach the strainer to

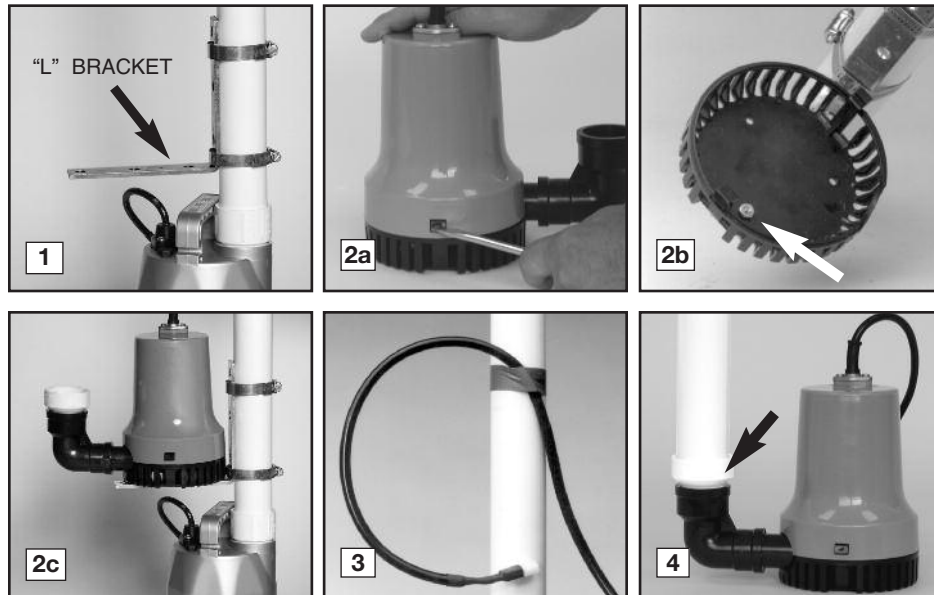

the "L" bracket. (c) Once the strainer is attached, simply press the rest of the pump onto the mounted strainer.

3. Secure the pump wire so that the plug on the end will not fall into the sump. Attach the wire to the pipe with a piece of tape.
4. Cut a piece of 1½" rigid PVC pipe long enough to reach from the elbow of the backup pump to (1) foot above the floor. Prime and cement it to the 1½" pipe adapter, then screw the adapter into the pump.
5. Attach a union or check valve to the top of the 1½" PVC pipe. This will allow the pump to be removed easily, should the need arise.

The path of the rest of the pipe and the details of each installation will vary. Using sound plumbing practices, try to route the discharge pipe to an exterior wall via the shortest path with the fewest turns. More turns will reduce the pumping capacity. The pipe section exiting the building should be on a downward slope so that the water in the pipe will exit outside instead of returning to the sump pit. Be sure to seal the hole in the wall where the pipe exits, and prime and cement or clamp all connections securely to

prevent leaking. (No check valve is needed with this method of installation as long as you use less than 20 feet of pipe.)

CAUTION

If you use more than a total of 20 feet of pipe in the installation, install a check valve in place of the union. Make sure it is installed with the arrow pointing up or it will not

prevent the backflow of water. When a check valve is used, a 1/8" hole must be drilled in the PVC pipe above the Basement Watchdog pump. Drill the hole at a 45° angle toward the bottom of the sump to avoid splashing water outside the sump pit. Make sure the hole is above the water line, and below the check valve. If a hole is not drilled above the pump, an air lock may prevent the pump from operating, and the basement will flood.

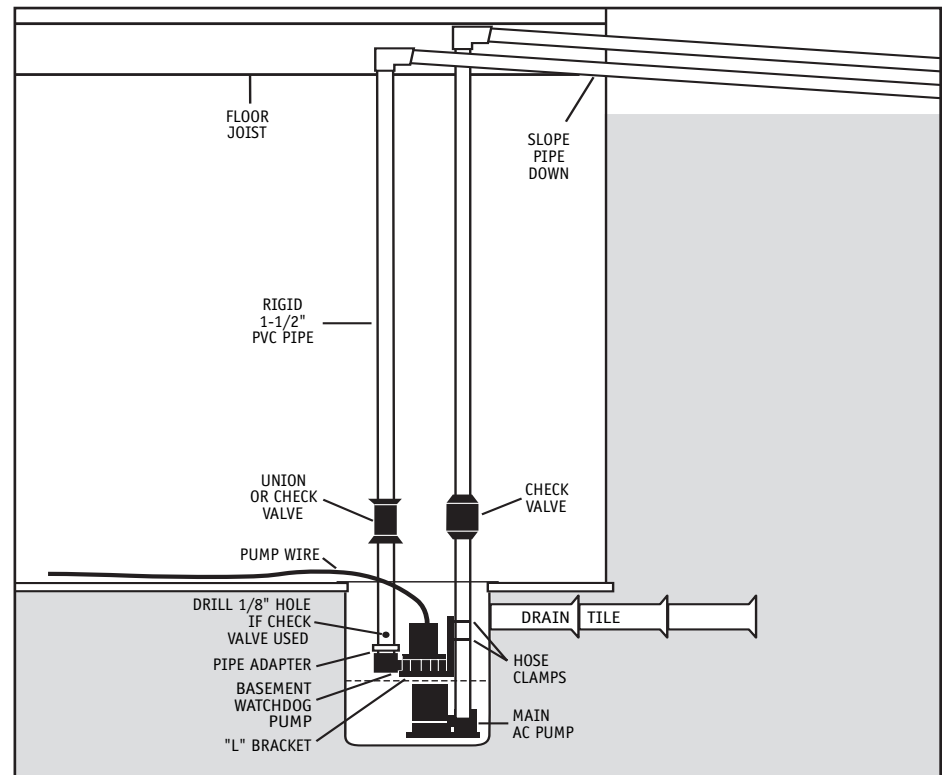
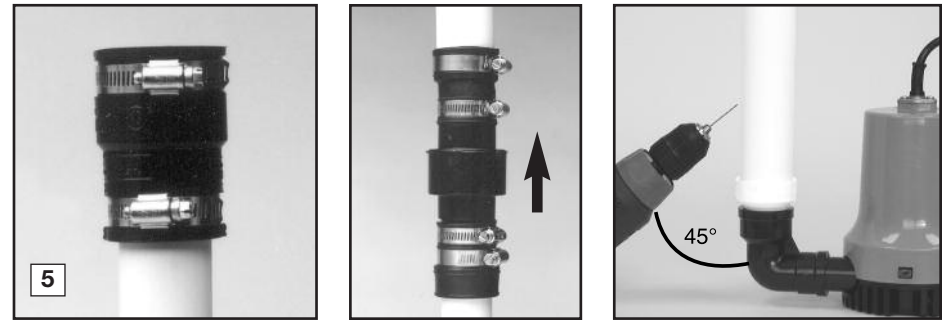

Diagram C

Pump & Pipe Installation Instructions

INSTALLATION D: CONNECTION TO EXISTING DISCHARGE PIPE FOR NARROW SUMP PITS (Diagram D)

Depending on your installation requirements, PVC pipe lengths will vary. Cut the pipes and assemble them as shown in photo #8. Do not cement them together until you are sure they are cut to the correct lengths. It is important to keep the discharge pipes on both pumps parallel to each other, so that the pumps remain flat on the floor of the sump. More detailed instructions follow.

⚠ DANGER

Unplug the main AC pump when installing the backup pump to avoid electric shock. Failure to do so could cause serious injury or death.

1. Attach an "L" bracket to the discharge pipe of

the main AC pump with two (2) stainless steel hose clamps. Position the bracket so the bottom of the "L" is just above the top of the main pump, and out of the way of any float switch on the main pump.

2. (a) Remove the black bottom strainer of the pump by pressing in the two tabs on the strainer and pushing down. There are holes suitable for mounting on the bottom of the strainer. (b) Using the #8-32 x 3/4" stainless steel screw, washer and nut, attach the strainer to the "L" bracket. (c) Once the strainer is attached, simply press the rest of the pump onto the mounted strainer.

3. Secure the pump wire so that the plug on the end will not fall into the sump. Attach the wire to the pipe with a piece of tape.

4. Cut a piece of 1 1/2" rigid PVC pipe long enough to reach from the elbow on the backup pump to one (1) foot above the floor. Prime and cement it to the 1 1/2" pipe adapter, then screw the adapter into the pump.

5. Install a check valve on the top of the PVC pipe attached to the Basement Watchdog pump. Make sure it is installed with the arrow pointing up or it will not prevent the backflow of water.

CAUTION

6. **When a check valve is used, a 1/8" hole must be drilled in the PVC pipe above the Basement Watchdog pump. Make sure it is above the water line and below the check valve. Drill the hole at a 45° angle toward the bottom of the sump to avoid splashing water outside the sump pit. If a 1/8" hole is not drilled above the pump, an air lock may prevent the pump from operating, and the basement will flood.**

7. If there is no check valve on the discharge pipe of the main AC pump, one must be installed at this time. Cut the discharge pipe approximately one (1) foot above the floor. Install a check valve on the pipe and tighten the bottom hose clamp. Now prime and cement a small piece of 1 1/2" PVC pipe to the

bottom of a "Y" connector. Prime and cement the top of the "Y" assembly to the discharge pipe with the "Y" extension facing down toward the backup pump. Now connect the bottom of the assembly to the check valve and tighten the hose clamp.

8. Connect a piece of 1 1/2" PVC pipe above the check valve of the Basement Watchdog pump, and attach a 45° elbow to that pipe. Extend another piece of pipe to reach from the 45° elbow to the "Y" connector on the other pipe.

9. Prime and cement all pipe connections securely to prevent leaking, and tighten all the hose clamps.

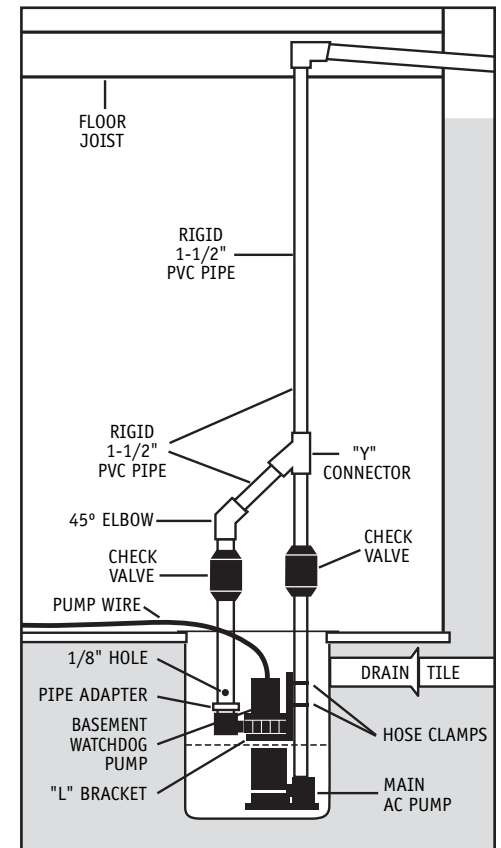
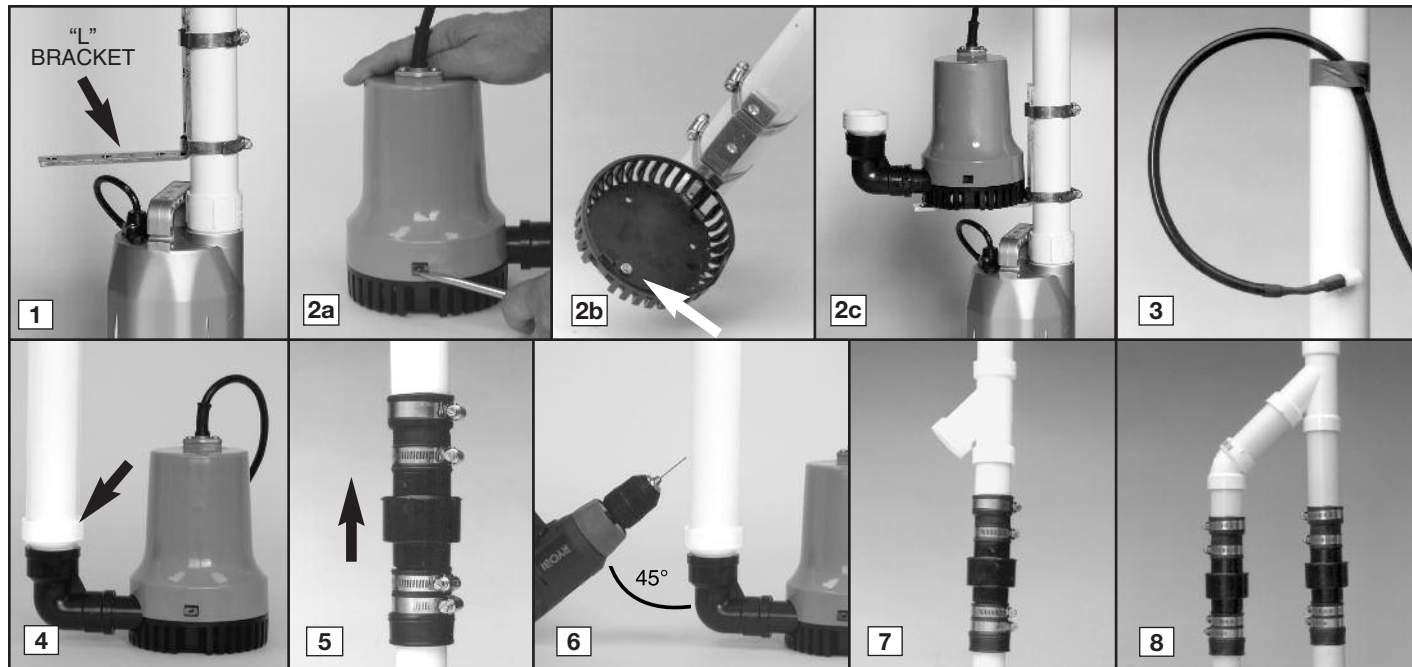

Diagram D

Battery Instructions

A new Basement Watchdog 7.5 Hour Standby Battery will run this system for a minimum of 7.5 hours continuously. However, most of the time the pump will turn on and off, and this battery will run the pump intermittently for days. In addition, the unique materials in the Basement Watchdog Standby batteries enable them to last for five to seven years in standby service.

CAUTION

- The use of automotive batteries is NOT recommended. Automotive batteries are not designed for this application. They will only run the pump for a short time and will have a shorter life than a standby battery.
- NEVER use a maintenance-free or sealed battery with this system
- The battery fluid sensor is designed to fit the Basement Watchdog Standby batteries. Measuring the battery fluid is one of the most important features of the system; since about 80% of backup sump pump failures are the result of a battery that has dried out.
- The internal construction of some wet cell batteries may not be compatible with this system. The use of a Basement Watchdog 7.5 Hour battery is HIGHLY recommended.

⚠ DANGER

Do not insert the fluid sensor into any battery except a Basement Watchdog battery. Do not drill a hole in another brand of battery to accommodate the fluid sensor. Do not use the enclosed battery cap on any battery except a Basement Watchdog battery. Do not drill a hole in the cap of another brand of battery to accommodate the fluid sensor. Batteries emit explosive gases, which can cause serious injury or death.

PREPARING THE BASEMENT WATCHDOG STANDBY BATTERY

The Basement Watchdog Standby batteries are shipped dry (without acid), so they never lose power before you take them home. A battery is activated when the acid is added, and then it slowly begins to deteriorate as it ages. By adding the acid just before use, the battery will always be fresh. Use 1.265 specific gravity battery acid to fill the battery. It is available where you

purchased the battery.

NOTE: BASEMENT WATCHDOG BATTERIES NOW COME IN TWO CONFIGURATIONS. THE TOPS OF THE BATTERIES LOOK DIFFERENT, AND THE DIRECTIONS FOR FILLING THE BATTERIES AND CONNECTING THE FLUID SENSOR WILL VARY SLIGHTLY. IF THE TOP OF YOUR BATTERY LOOKS LIKE PHOTO A, FOLLOW THE INSTRUCTIONS ON THIS PAGE. IF THE TOP OF YOUR BATTERY LOOKS LIKE PHOTO B ON PAGE 9, FOLLOW THE INSTRUCTIONS ON PAGE 9.

⚠ DANGER/POISON

Contains sulfuric acid. Wear eye and clothing protection. If battery acid contacts skin or clothing, wash immediately with soap and water. If acid enters eyes, flush with water for 15 minutes, and get prompt medical attention. Review the safety instructions on page 1.

TO FILL THE BATTERY

1. Remove the cover of the battery box by pushing in the tabs on the front and back of the box and lifting up.
2. Place the battery box on the floor. Place the dry (unfilled) battery into the battery box. Remove the foil seal on the top of the battery.
3. Carefully push in the perforated tab at the top of the acid pack. Lift up the large tab and pull out the dispensing hose. Hold the hose upright above the pack and squeeze the hose forcing all the acid back into the pack.
4. Position the acid pack and battery as shown at the right. Pinch the end of the hose together and cut off the tip. Insert the end of the hose into each cell. Control the flow by pinching the hose with thumb and forefinger. *Fill each cell of the battery to a level just covering the battery plates, and then go back and top off each cell equally. It is important to have all the cells filled equally or the battery will not operate properly.* The acid should reach a level about $\frac{3}{4}$ " below the cap ring as shown in the diagram at right. DO NOT OVERFILL THE BATTERY. (Diagram E)

A newly filled battery will sometimes require additional acid after about 20 minutes. Re-examine the fill level, and add additional acid if necessary. The battery acid may bubble at this

time and give off a sulfur-like smell, but this is normal. After the battery has been filled, screw the six (6) caps securely on the top of the battery.

CAUTION

When you fill the battery for the FIRST time, it will be the ONLY time you add acid to the battery. In the future, when the fluid level is low, add distilled water to the cells. NEVER add more acid.

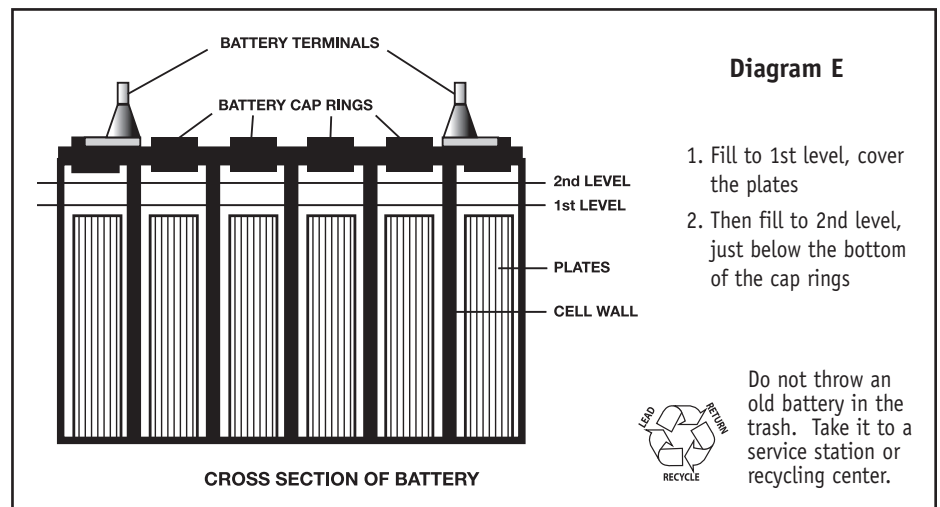
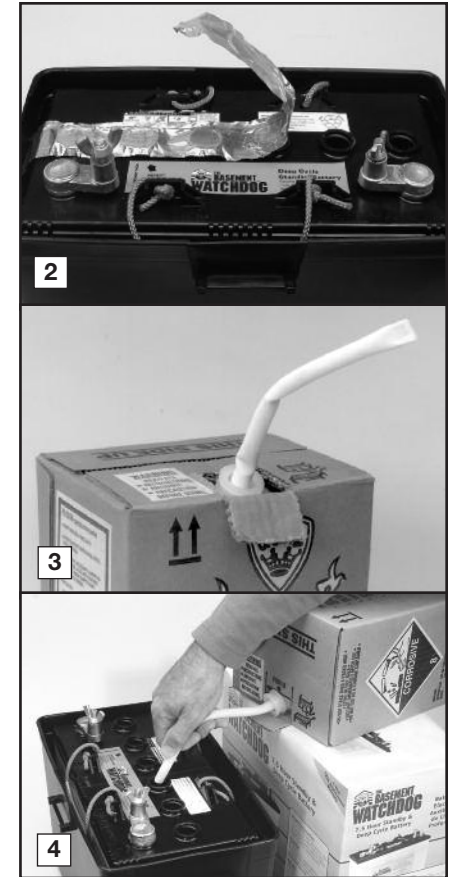
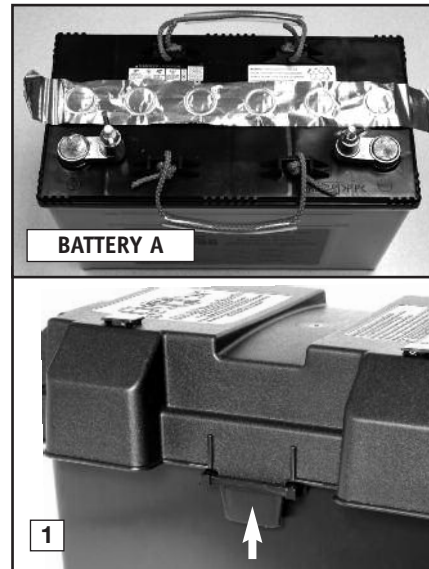



If your battery looks like the battery above, follow these instructions:

1. Remove the cover of the battery box by pushing in the tabs on the front and back of the box and lifting up.
2. Place the battery box on the floor. Place the dry (unfilled) battery into the battery box. Remove the two battery caps by carefully prying them up with a screwdriver as shown on the right. Place the screwdriver in the middle of the cap on the top of the battery. **DO NOT** lift the cap by prying it up from the groove on the back of the battery. It may damage the vent.
3. Carefully push in the perforated tab at the top of the acid pack. Lift up the large tab and pull out the dispensing hose. Hold the hose upright above the pack and squeeze the hose forcing all the acid back into the pack.
4. Position the acid pack and battery as shown at the right. Pinch the end of the hose together

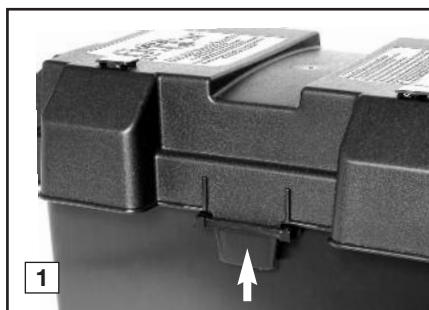

and cut off the tip. Insert the end of the hose into each cell. Control the flow by pinching the hose with thumb and forefinger. **Fill each cell of the battery to a level just covering the battery plates, and then go back and top off each cell equally. It is important to have all the cells filled equally or the battery will not operate properly.** The acid should reach a level about $\frac{1}{4}$ " below the cap ring as shown in the diagram below. **DO NOT OVERFILL THE BATTERY.** (Diagram E)

A newly filled battery will sometimes require additional acid after about 20 minutes. Re-examine the fill level, and add additional acid if necessary. The battery acid may bubble at this time and give off a sulfur-like smell, but this is normal. After the battery has been filled, press the caps securely on the top of the battery.

CAUTION

When you fill the battery for the FIRST time, it will be the ONLY time you add acid to the battery. In the future, when the fluid level is low, add distilled water to the cells. NEVER add more acid.

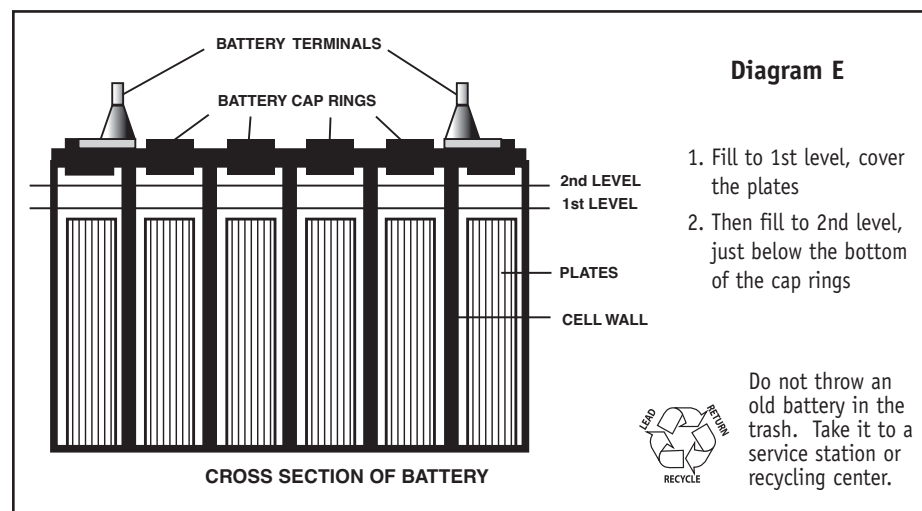

Control Unit Connections

⚠ DANGER

Risk of electrical shock or battery explosion, which can cause serious injury or death. **Unplug the main AC pump to avoid electrical shock. Wear eye protection. Work in a well-ventilated area. Do not smoke or allow a spark or flame in the vicinity of the battery. Avoid dropping metal tools on the battery. If battery acid contacts eyes, flush with water for 15 minutes and get prompt medical attention. Review the safety instructions on page 1.**

When you position the battery with the control unit on the top, be sure the charger cord will reach the AC power outlet, and the pump cable and the float switch will reach the bottom of the sump. Position the unit in a well-ventilated area. (Diagram F)

1. **Positioning the dual float switch:** The float switch will activate the pump when the water raises either float, and it will remain running as long as the water is above the float. When the water drops below the float switch, an internal timer in the control unit will keep the pump running an additional 25 seconds to empty the sump pit. The switch should be mounted about six (6) inches above the water level line in the sump pit. (a) Attach the float switch very securely to the discharge pipe with the plastic wire tie. (b) If the pump is stacked above the main AC pump in a narrow sump pit, the float may be attached to the elbow of the pump. *Be sure the switch is positioned vertically with the mounting bracket at the top. Do not tilt the switch. Do not position the float switch on the side of the discharge pipe facing the drain tile or any incoming rush of water!*
2. **Connecting the pump:** Remove the security tag from the pump and plug the pump wires into the pump connector on the back of the control unit. Keep the backup pump wire, the AC pump wire, and the float wire separate from each other. Do not let them cross on the final installation.

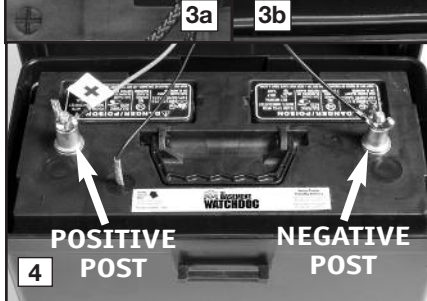
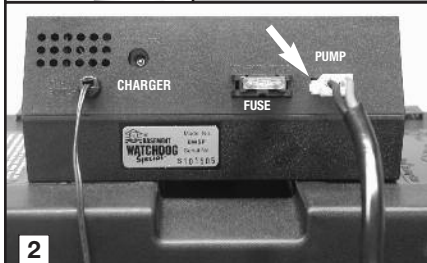
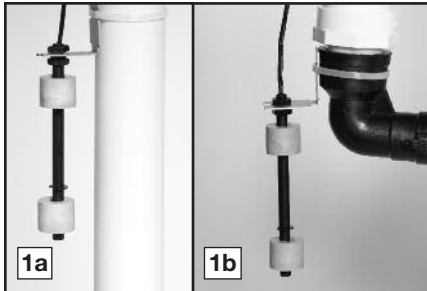

3. **Installing the battery fluid sensor:** BASEMENT WATCHDOG BATTERIES COME IN TWO CONFIGURATIONS. THE HOLE FOR THE FLUID SENSOR IS MARKED BY AN ARROW ON THE TOP OF EACH BATTERY. Remove the cover of the battery box by pushing in the tabs on the front and back, then lifting up. Fan the area around the top of the battery with a piece of cardboard (or another non-metallic material)

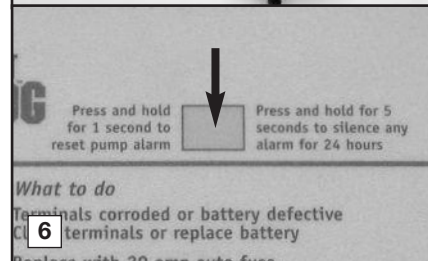
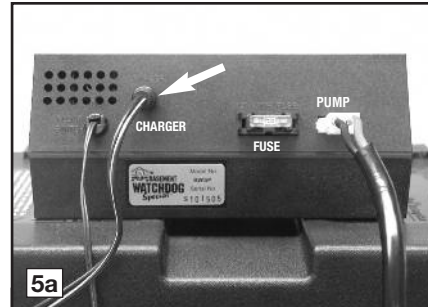

to remove any hydrogen or oxygen gas that may have been emitted from the battery. (a) If the top of the battery has six small battery caps, replace the battery cap that is 2nd from the POSITIVE (+) post with the battery cap that is provided in the Basement Watchdog package. An arrow on the top of the battery marks this position. There are two holes in this battery cap. Insert the fluid sensor in the hole that is off-center on the top of the cap. Do not glue the sensor into the cap. (b) If the top of the battery has two large caps, place the fluid sensor in the hole molded on the top of the battery. It is located in the second cell from the positive post, and the location is marked by an arrow on the top label. Hold the sensor straight up and press it firmly into the hole. Do not bend the sensor. You will not need the additional battery cap provided in the carton if you have this battery.

CAUTION

If you are not using the Basement Watchdog Standby battery, you cannot use the battery fluid sensor. However, you must attach the sensor to the POSITIVE (+) post of the battery or the alarm will sound continuously. The Basement Watchdog sump pump system will not warn you if the fluid level is low in this configuration. You will need to check your battery every couple of months to see if it needs water. If the battery dries out, the system will not work.



4. **Connecting the battery:** Remove the wing nuts from the battery terminals. Remove the

security tag from the battery cables. Attach the battery cables to the battery...the BLACK wire to the NEGATIVE (-) post, and the RED wire to the POSITIVE (+) post. Replace the wing nuts and tighten them.

5. **Connecting the charger:** Immediately plug the charger into the charger hole on the back of the control unit, then into an AC outlet on the wall. (You should provide additional protection for the control unit by using a surge protector.)
6. If the pump alarm is sounding, press the YELLOW button on the front of the control panel to reset the alarm.
7. Secure the cover on the battery box by slipping the tabs through the fittings on the front and back of the box.

8. BE SURE TO PLUG IN THE MAIN AC PUMP.

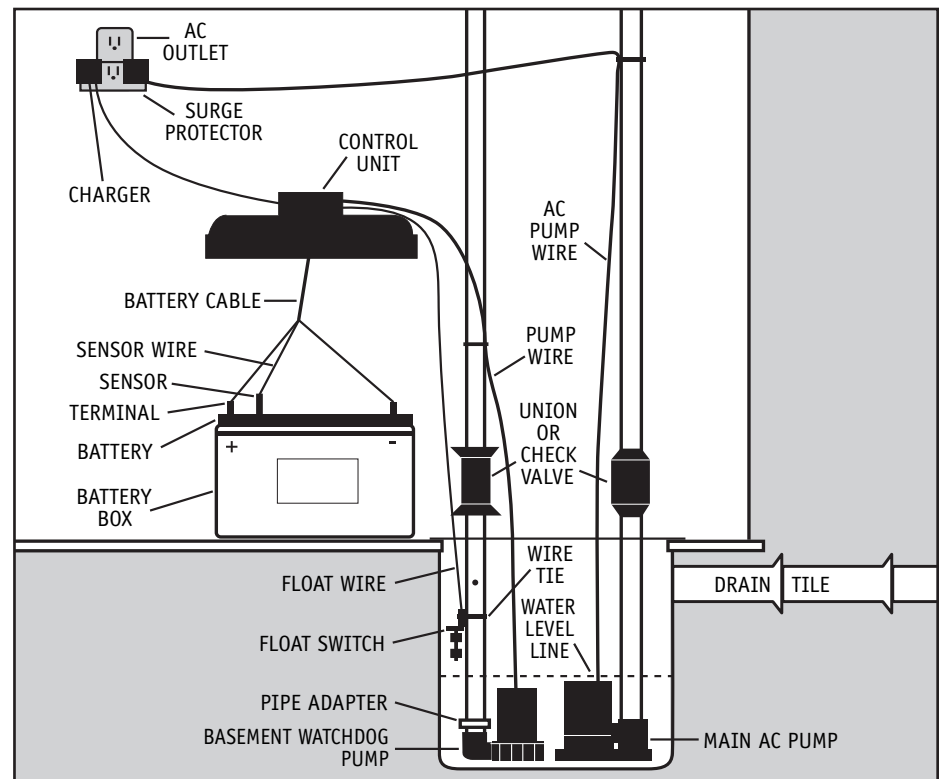

Diagram F

Understanding the Warnings & Alarms

The Basement Watchdog control unit features a series of warning lights that pinpoint potential problems. In addition, an alarm sounds to alert you to the problem. In some cases the lights and alarm will go off automatically when the problem has been solved. In others, the YELLOW button must be pushed to reset the alarm. Refer to the table below for a quick review of the features and their corresponding alarm status.

Warning	Alarm can be silenced before problem is corrected	Alarm shuts off automatically when the problem is corrected
Battery	No	No, must push YELLOW button
Fuse	No	Yes
Water	Yes	Yes
Pump	Yes	No, must push YELLOW button
Power	Yes	Yes, but light will flash until YELLOW button is pushed

SILENCING THE ALARM DURING AN EMERGENCY

The Basement Watchdog Special allows you to silence some of the alarms during an emergency, however the warning lights will remain on until the problem is corrected.

- Press the YELLOW button on the front of the control panel for one (1) second to reset the “Pump” alarm, and silence the “Water” and “Power” alarms for two (2) minutes.
- Press the YELLOW button for five (5) seconds to silence these alarms for 24 hours. A brief buzzing sound will notify you that the alarms have been silenced. The alarms will automatically reactivate in 24 hours if the warning condition still exists.

① Battery

This light and alarm will come on when the control unit detects there is less than ½ hour of pumping power left in the battery, or that the battery is defective. The alarm cannot be silenced, because action needs to be taken to protect your basement. If your battery is more than five (5) years old, replace it. If not, here are several situations that would cause the pump

to run the battery for an extended time and discharge the battery: Check the list below before you replace the battery.

- If the bottom light on the controller is also on, it means that the unit is not receiving AC power. Either the AC power is out, the circuit breaker has blown, or the outlet is bad. When the problem is corrected, the battery should recharge.
- If the fourth light on the controller is also on, check your main pump for failure. The backup pump may have been activated repeatedly if your main AC pump is broken, or you are experiencing heavy rains and your main pump cannot keep up with the inflow of water. You may need to upgrade or replace your main pump. When the problem is corrected, the battery should recharge.
- If no other lights are on, this means the terminals may be corroded, and the battery cannot charge properly. Unplug the charger from the wall outlet. Then, check the battery cables and the battery terminals for corrosion. Clean and tighten them as needed. The procedure is described in the next column and on page 12.
- If the battery terminals have been cleaned and the light is still on, there could be a problem with the controller or the battery. The best way to determine if the battery is the problem is to have it charged and load tested at any local car service station. If the battery is bad and less than one (1) year old, it can be returned to the place of purchase for a replacement (receipt required). If the battery is good, contact Glentronics’ service department for further instructions. The phone number is 800-991-0466, option #3.

If the battery alarm goes on while the pump is running and the power is out, you will have a minimum of one-half (1/2) hour of continuous pumping time to replace the battery. (In most cases, the pump does not run continuously, and therefore, you actually have a longer time to replace it.) You will not be able to silence the

alarm. Left unattended, the basement will flood. In a severe emergency, if a replacement battery is not available, you could temporarily use your car battery, or recharge this battery by connecting it to your car battery.

Once the AC power is restored, the battery will recharge automatically, unless it is old or damaged. The alarm will remain on until the YELLOW button on the front of the control panel is pressed for one (1) second.

In the event that your Basement Watchdog sump pump system has pumped for an extended period of time, the battery may be very depleted. In this condition, when the AC power is returned to the unit, a battery alarm will continue to sound. The battery may need a longer period to recharge.

For a faster recharge, an automotive or marine battery charger can be used to recharge the battery. Follow the manufacturer’s instructions and safety information included with the charger.

⚠ WARNING

When another charger is used, first disconnect the Basement Watchdog charger from the control unit, and then disconnect the control unit from the battery. Using another charger without disconnecting the control unit will destroy the control unit and void the warranty.

TO CLEAN THE BATTERY TERMINALS AND CABLES

⚠ DANGER

Risk of electrical shock or battery explosion, which can cause serious injury or death. Wear eye protection. Work in a well-ventilated area. Do not smoke or allow a spark or flame in the vicinity of the battery. Avoid dropping metal tools on the battery. If battery acid contacts eyes, flush with water for 15 minutes and get prompt medical attention. Review the safety instructions on page 1.



Press and hold for 1 second to reset pump alarm



Press and hold for 5 seconds to silence any alarm for 24 hours

Battery Backup Sump Pump System

	<i>Warning</i>	<i>What to do</i>			
①	● Battery	Terminals corroded or battery defective Clean terminals or replace battery			
②	● Fuse	Replace with 20 amp auto fuse If fuse blows again, replace pump			
③	● Water	Add distilled water to battery			
④	● Pump	Pump was activated Check main pump for failure			
⑤	● Power	Check the circuit breaker Make sure charger is plugged into wall & controller If power is on, replace the charger	⑥	● Charging	
			⑦	● System Operating	

Computer-Controlled Automatic Charging & Monitoring System

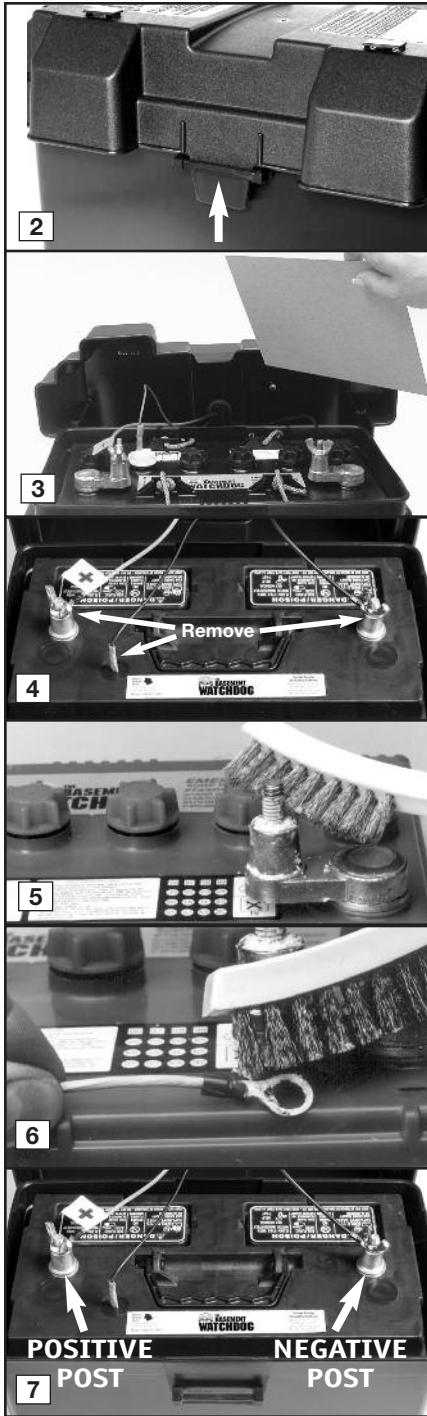

REFER TO THE PHOTOS AT LEFT

1. Unplug the charger from the wall outlet.
2. Remove the cover of the battery box by pushing in the tabs on the front and back, then lifting up.
3. Fan the area around the top of the battery with a piece of cardboard (or another non-metallic material) to remove any hydrogen or oxygen gas that may have been emitted from the battery.
4. Remove the fluid sensor from the battery. Unscrew the wing nuts. Remove the battery cables.
5. Clean the battery posts with a battery terminal cleaner or a wire brush.
6. Clean any corrosion off of the ring connectors on the ends of the battery wires. Use a stiff brush or sandpaper. **DO NOT** apply corrosion resisting sprays or pads to the terminal rings or posts after you have cleaned them, since this could prevent the system from charging properly.
7. Replace the fluid sensor in the top of the battery. Then replace the battery cables, BLACK to the NEGATIVE (-) post and RED to the POSITIVE (+) post. Tighten the wing nuts.
8. Plug the charger back into the wall outlet. (You should provide additional protection for the control unit by using a surge protector.)
9. If any of the alarms are sounding, press the YELLOW button on the front of the control panel for one (1) second.



REPLACING THE BATTERY

⚠ DANGER

Risk of electrical shock or battery explosion, which can cause serious injury or death. Wear eye protection. Work in a well-ventilated area. Do not smoke or allow a spark or flame in the vicinity of the battery. Avoid dropping metal tools on the battery. If battery acid contacts eyes, flush with water for 15 minutes and get prompt medical attention. Review the safety instructions on page 1.

REFER TO THE PHOTOS AT RIGHT

1. Unplug the charger from the wall outlet.
2. Remove the cover of the battery box by pushing in the tabs on the front and back, then lifting up.
3. Fan the area around the top of the battery with a piece of cardboard (or another non-metallic material) to remove any hydrogen or oxygen gas that may have been emitted from the battery.
4. Remove the fluid sensor from the top of the battery. Unscrew the wing nuts and remove the battery cables.
5. Remove the old battery from the battery box and place the new battery in the box. Fill the battery following the instructions on page 8 or 9.
6. Clean any corrosion off of the ring connectors on the ends of the battery wires. Use a stiff brush or sandpaper. **DO NOT** apply corrosion resisting sprays or pads to the terminal rings or posts after you have cleaned them, since this could prevent the battery from charging properly.
7. Replace the battery cables, BLACK to the NEGATIVE (-) post and RED to the POSITIVE (+) post. Tighten the wing nuts.

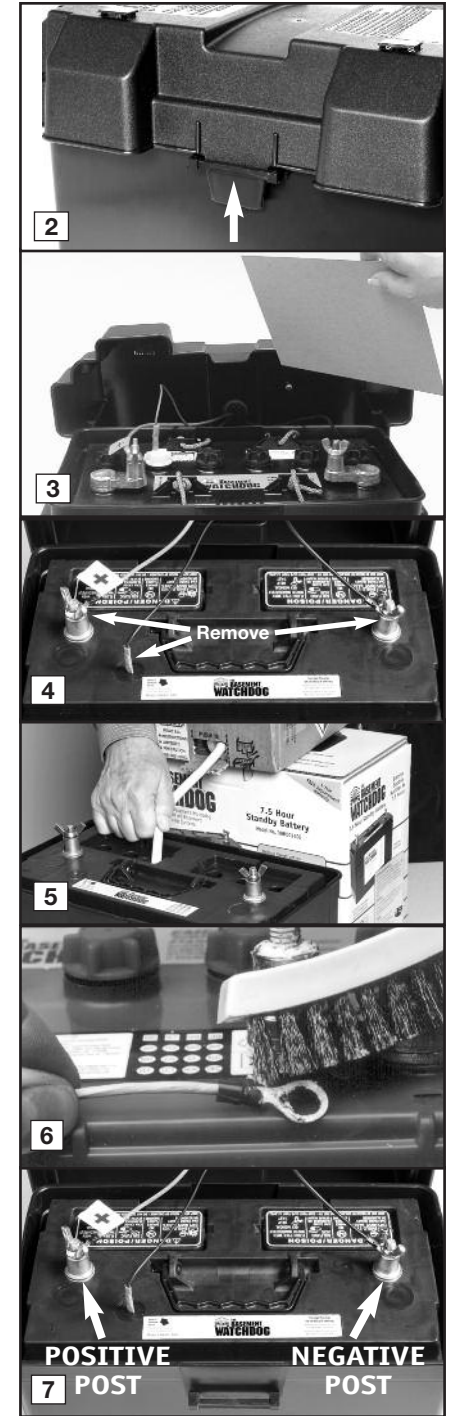

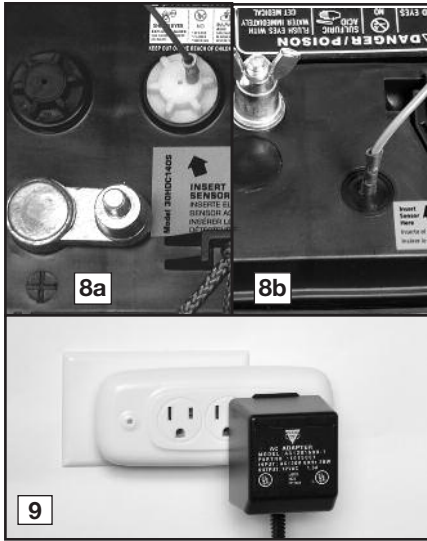

8. (a) If your battery has six (6) caps on the top, rinse and dry the cap with the extra hole from the old battery to remove any residue. Replace the battery cap in the cell that is 2nd from the POSITIVE post with the cap from the old battery. Insert the fluid sensor in the cap. (b) If your battery has two caps, each covering three (3) battery cells, you will not need to save the cap from the old battery. Simply insert the fluid sensor in the top of the battery next to the arrow.
9. Plug the charger back into the wall outlet. (You should provide additional protection for the control unit by using a surge protector.)
10. If any of the alarms are sounding, press the YELLOW button on the front of the control panel for one (1) second.

② Fuse

⚠ DANGER

Unplug the main AC pump before servicing the backup pump to avoid electric shock. Failure to do so could cause serious injury or death.

This alarm indicates that the 20 amp safety fuse on the back of the control unit has blown. This can be the result of a clogged pump motor, or

pump wires that have been shorted out. To determine the problem:

REFER TO THE PHOTOS BELOW

- Check the pump plug in the back of the unit to make sure it is firmly connected. Check the pump wires to make sure they are connected securely to the pump plug. Check the rest of the pump wires for any possible breaks.
- If the pump wires are intact, the pump may be clogged. (a) Disconnect the control unit from the wall outlet, and disconnect the battery cables. (b) Release the union or check valve and remove the pump and rigid PVC pipe section from the sump pit. (c) Clear any debris from the strainer, and then reconnect the pump to the discharge pipe. (d) Connect the control unit, and the battery cables to the battery...the BLACK wire to the NEGATIVE (-) post, and then the RED wire to the POSITIVE

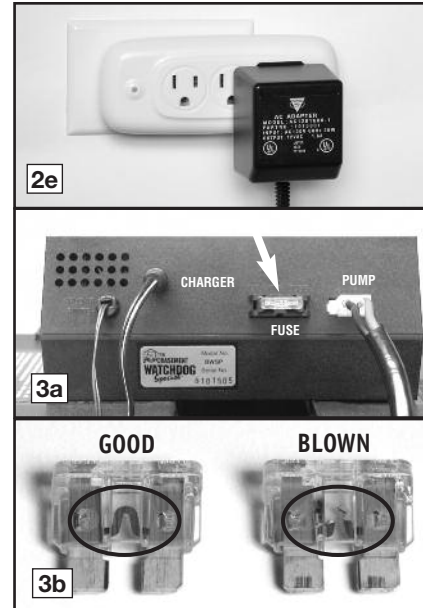
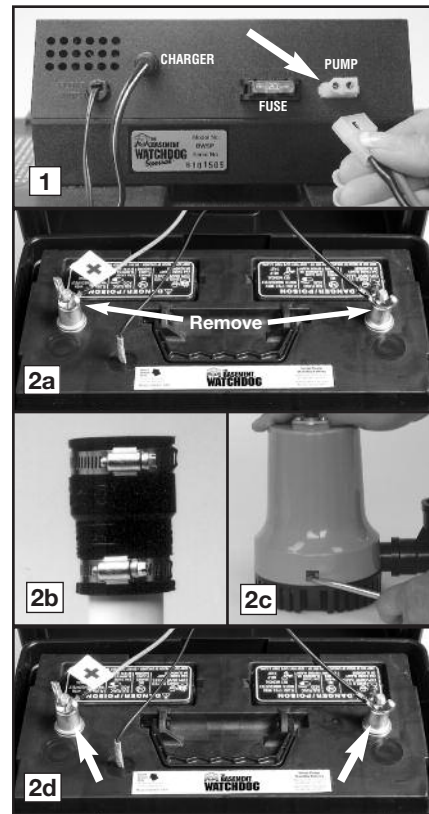

- (+) post. Tighten the wing nuts on the battery posts. (e) Plug the control unit back into the wall outlet.
- (a) Check the DC fuse by pulling it out of the fuse holder. (b) If the wires are burned and broken, replace the fuse with a 20 amp DC safety fuse. If the fuse blows again, unplug the computer control unit from the wall and disconnect the battery cables from the battery. Then call Glentronics technical support for instructions at 800-991-0466, option #3. You may need to replace the pump.
 - Plug the main AC pump back into the wall outlet.

③ Water

⚠ DANGER

Risk of electrical shock or battery explosion, which can cause serious injury or death. Wear eye protection. Work in a well-ventilated area. Do not smoke or allow a spark or flame in the vicinity of the battery. Avoid dropping metal tools on the battery. If battery acid contacts eyes, flush with water for 15 minutes and get prompt

medical attention. Review the safety instructions on page 1.

REFER TO THE PHOTOS AT RIGHT

If this warning light and alarm are on, you need to add distilled water to the battery.

- Unplug the charger from the wall outlet.
- Remove the cover of the battery box by pushing in the tabs on the front and back, then lifting up.
- Fan the area around the top of the battery with a piece of cardboard (or another non-metallic material) to remove any hydrogen or oxygen gas that may have been emitted from the battery.
- Then unscrew the wing nuts and remove the battery cables and the fluid sensor from the battery.
- Remove the battery caps. Add distilled water to each cell. If distilled water is not available, tap water with a low mineral content may be used. Well water is not recommended. **NEVER ADD MORE ACID.** Fill the battery to level 2 as shown in Diagram E on page 8. (The Basement Watchdog battery filler will automatically fill the level to the correct height. See enclosed order form.)
- Replace the battery caps. Replace the fluid sensor in the hole on the top of the battery. Be sure the fluid sensor is positioned in the 2nd cell from the positive post. The hole is marked with an arrow. Replace the battery cables...the BLACK wire to the NEGATIVE (-) post, and the RED wire to the POSITIVE (+) post. Replace the wing nuts and tighten.
- Replace the cover on the battery box.
- Plug the charger back into the outlet. (You should provide additional protection for the control unit by using a surge protector.)
- If any of the alarms are sounding, press the YELLOW button on the front of the control panel for one (1) second.

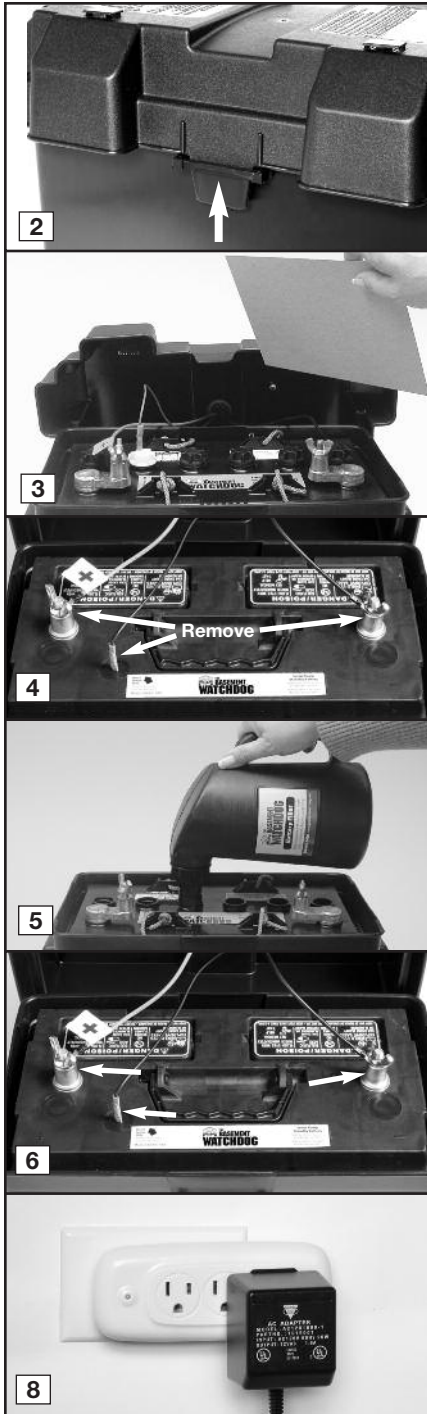

④ Pump

When the water rises in the sump pit and activates the float switch, the pump will begin pumping, and the "Pump was activated" light and alarm will turn on. Try to determine what caused the system to activate.

- Check the main AC pump for failure. It may not be working, the float switch may be stuck, or it may be too small to handle the inflow of water.
- Make sure the check valve is working and installed correctly
- Make sure the discharge pipe is not clogged or frozen
- If the power was out, the backup pump was automatically activated. You need to push the YELLOW button on the front of the control panel to silence the alarm.

REPLACING THE PUMP

⚠ DANGER

Unplug the main AC pump when installing or servicing the backup pump to avoid electric shock. Failure to do so could cause serious injury or death. Review the safety instructions on page 1.

REFER TO PHOTOS AT RIGHT

1. Unplug the charger from the wall outlet.
2. Remove the cover of the battery box by pushing in the tabs on the front and back, then lifting up.
3. Fan the area around the top of the battery with a piece of cardboard (or another non-metallic material) to remove any hydrogen or oxygen gas that may have been emitted from the battery.
4. Remove the fluid sensor and the battery cables from the battery.

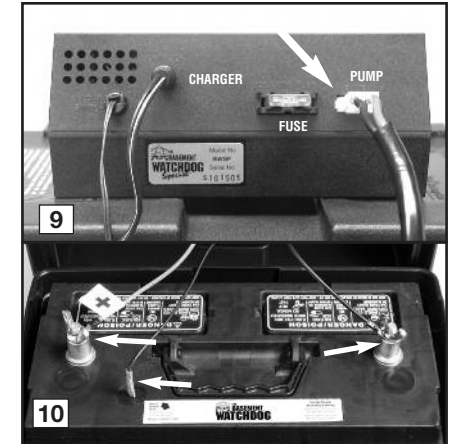
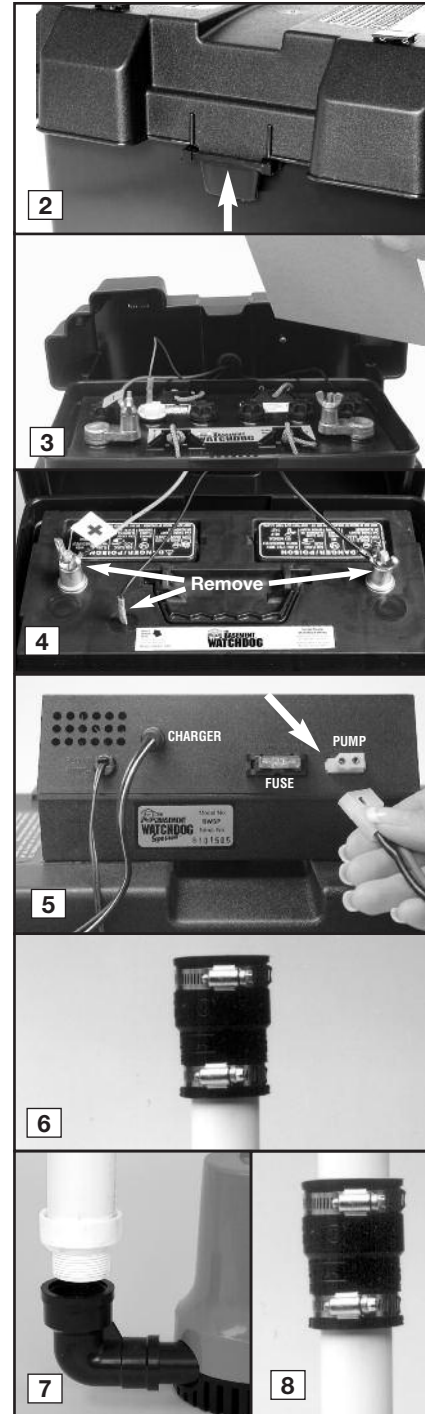

5. Unplug the pump from the back of the control unit.
6. Release the union or check valve and remove the pump and the rigid PVC pipe section from the sump pit.
7. Unscrew the pipe and adapter from the old pump, and screw them into the new pump.
8. Lower the pump into the sump and reconnect the union or check valve.
9. Plug the pump wires into the back of the control unit.
10. Replace the fluid sensor in the battery. Connect the battery cables to the battery...the BLACK wire to the NEGATIVE (-) post, and then the RED wire to the POSITIVE (+) post. Tighten the wing nuts.
11. Replace the cover on the battery box.
12. Plug the charger and the main AC pump back into the wall outlet. (You should provide additional protection for the control unit by using a surge protector.)
13. If any alarms are sounding, press the YELLOW button for one (1) second to silence them.

⑤ Power

There are several causes for power failure. The most common is a power outage by your electric company. During this emergency, the Basement Watchdog system will automatically switch to battery power and protect your basement from flooding.

For your convenience, the "Power" alarm has a built-in memory that will notify you when a power outage has occurred, and the power has since been restored. The alarm will turn off when the power is restored, but the "Power failure" light will flash (like your clocks). The flashing light will continue until the YELLOW button on the front of the control panel is pressed for 1 second.

You can silence the "Power" alarm for 24 hours by pressing the YELLOW button for 5 seconds. The alarm will be silence, but the light will stay on. The system will continue to operate while the power alarm is silenced. After 24 hours, the alarm will reset automatically.

1. If the power is on in the rest of the house, check the home circuit breaker or fuse box for failure, and correct the problem.
2. Check the charger. Make sure it is securely plugged into the wall outlet. Make sure the power outlet is working.

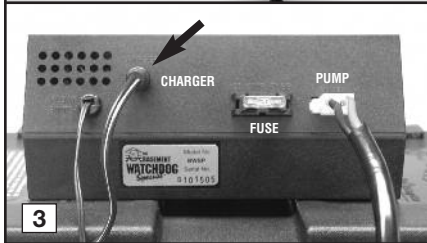

3. Check the charger plug that fits into the rear panel of the control unit. Make sure it is securely plugged into the control unit.

The control unit must receive 115 volts AC +/- 5% from the AC outlet. Any voltage lower than 110 volts will activate the power failure alarm. Lower voltages can be caused by utility company brown outs or a heavy power draw from other appliances on the same circuit. Reduce the number of appliances on the circuit.

If all the connections are secure and the wall outlet is operating, but the "Power" warning light is still on, replace the charger unit with the Basement Watchdog part number 1015001 from Glentronics at 800-991-0466, option #3.

⑥ Charging

The Basement Watchdog Special is equipped with a computer-controlled automatic charging system. The computer is constantly monitoring the battery and will supply a pre-programmed amount of energy to keep your battery at full charge. The "Charging" light will be on while the battery is charging, and off when it is not charging. The normal charge cycle is in one-hour increments, which increases the life of the battery and reduces the amount of water loss. If the battery is discharged from extended use, the charger light will remain on until the battery is completely recharged.

⑦ System Operating

This light will always be on when there is power coming from either the battery or the outlet.

TEST-RESET-SILENCE BUTTON

To test the pump, press the YELLOW button for 1 second. The pump will run for 25 seconds and then shut off automatically.

To silence any alarm, press the YELLOW button for 1 second.

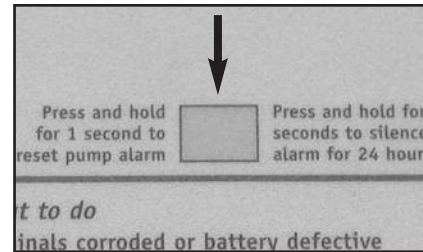

To reset the BATTERY or PUMP alarm, press the button for 1 second.

To silence all the alarms for 24 hours, press the YELLOW button for 5 seconds until you hear a buzz. The alarms will automatically re-activate in 24 hours.

TESTING THE FLOAT SWITCH

It is important to manually test the float switch periodically.

⚠ DANGER
Unplug the main AC pump when installing or servicing the backup pump to avoid electric shock. Failure to do so could cause serious injury or death. Review the safety instructions on page 1.

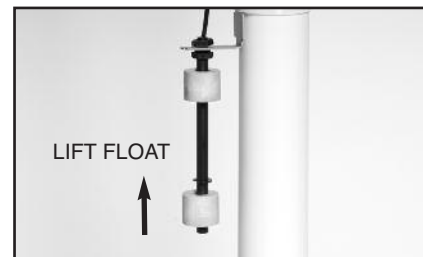

Lift the float up and let go. This will activate the pump. The control unit will run the pump for approximately 25 seconds so it can empty all the water in the sump pit. If there is no water in the pit, the pump can run dry for this amount of time. The alarm will sound and the "Pump" light will go on. After the pump has stopped, push the YELLOW button to silence the alarm. **BE SURE TO PLUG IN THE MAIN AC PUMP WHEN YOU HAVE COMPLETED THE TEST.**

PARTS & SERVICE INFORMATION

You can receive technical support parts or service information by calling Glentronics, Inc. at **800-991-0466, option #3**, or by visiting the Basement Watchdog website at **www.basementwatchdog.com**. Send your unit to the following address if repairs are needed:

Glentronics, Inc.
645 Heathrow Drive
Lincolnshire, IL 60069-4205

Troubleshooting Guide

⚠ DANGER Read safety warnings & instructions before attempting any repairs or maintenance.

BATTERY ALARM

Possible Reasons	Remedies
Terminals are corroded	Clean terminals & cables
Cables are loose	Tighten wing nuts
Battery is discharged	Replace battery if power is out. There is only 1/2 hour of continuous pumping power left. Battery will recharge when power is restored
Battery is damaged or old	Replace battery

FUSE ALARM

Possible Reasons	Remedies
Pump is clogged	Remove pump and strainer. Clean out any debris Replace the 20-amp fuse
Pump wires are exposed	Replace the pump
Pump is defective	Replace the pump

WATER ALARM

Possible Reasons	Remedies
The battery fluid is low	Add distilled water to the battery

PUMP ALARM

Possible Reasons	Remedies
The main AC pump failed because of a power outage	None. The backup pump was activated
The main AC pump is defective	Replace the main AC pump
The float switch on the main AC pump is jammed or defective	Free the float switch or replace it
The main AC pump could not keep up with the inflow of water	None. The backup pump was activated. If this is a recurring problem, install a higher capacity main pump
The float switch on the backup pump is defective	Replace the float switch
The check valve is stuck or installed improperly and the water returns to the sump pit	Replace the check valve or correct the installation
The discharge pipe is blocked and the water returns to the sump pit	Clean out or replace the discharge pipe

POWER ALARM

Possible Reasons	Remedies
Power outage	None. The backup pump will run on the battery
A fuse or circuit breaker has failed	Replace the fuse or reset the circuit breaker
The charger is unplugged from the back of the control unit, or unplugged from the wall	Make sure the charger is plugged in securely
The charger is receiving less than 110 volts from the outlet	None, if the utility company has instigated brown outs. Otherwise, reduce the number of other appliances on the circuit

Limited Warranty

GLETRONICS, INC. warrants to the original retail purchaser that all of its pump, switch, sensor, battery box and control unit products are free from defective materials and workmanship for the period indicated below:

All parts and labor (excluding installation) for a period of
two (2) years from the date of purchase

The defective product must be returned directly to the factory, postage prepaid with the original bill of sale or receipt to the address listed below. Glentronics, Inc., at its option, will either repair or replace the product and return it postage prepaid.

CONDITIONS

The unit must be shipped freight prepaid, or delivered, to Glentronics, Inc. to provide the services described hereunder in either its original carton and inserts, or a similar package affording an equal degree of protection.

The unit must not have been previously altered, repaired or serviced by anyone other than Glentronics, Inc., or its agent; the serial number on the unit must not have been altered or removed; the unit must not have been subject to accident, misuse, abuse or operated contrary to the instructions contained in the accompanying manual.

The dealer's dated bill of sale, or retailer's receipt, must be retained as evidence of the date of purchase and to establish warranty eligibility.

This warranty does not cover product problems resulting from handling liquids hotter than 120 degrees Fahrenheit, handling inflammable liquids, solvents, strong chemicals or severe abrasive solutions; normal wear; user abuse; misuse, neglect, improper maintenance, commercial or industrial use; improper connections or installation; damages caused by lightning strikes, excessive surges in AC line voltage, water damage to the controller, other acts of nature, or failure to operate in accordance with the enclosed written instructions.

GLETRONICS, INC. WILL NOT BE LIABLE FOR ANY INCIDENTAL, SPECIAL OR CONSEQUENTIAL DAMAGES FOR BREACH OF ANY EXPRESS OR IMPLIED WARRANTIES ON THIS PRODUCT. SOME STATES DO NOT ALLOW THE EXCLUSION OR LIMITATION OF CONSEQUENTIAL OR INDIRECT DAMAGES, SO THE ABOVE LIMITATION MAY NOT APPLY TO YOU. THIS EXPRESS WARRANTY SHALL BE EXCLUSIVE AND IS IN LIEU OF ALL OTHER WARRANTIES, WRITTEN OR ORAL, EXPRESS OR IMPLIED, INCLUDING, BUT NOT LIMITED TO ANY WARRANTY OF MERCHANTABILITY OR FITNESS FOR A PARTICULAR PURPOSE. THE CUSTOMER'S EXCLUSIVE REMEDY FOR BREACH OF THIS WARRANTY, OR OF ANY IMPLIED WARRANTY NOT EXCLUDED HEREIN, SHALL BE LIMITED TO REPAIR OR REPLACEMENT OF THE PRODUCT.

For information or service contact:

Glentronics, Inc.
645 Heathrow Drive
Lincolnshire, IL 60069
800-991-0466

Model # BWSP Serial # _____ Purchase Date _____

Register online at www.basementwatchdog.com

CHECK OUT THESE OTHER BASEMENT WATCHDOG PRODUCTS

AC PUMPS

Industrial Grade Pumps for the Residential Market

The Basement Watchdog line of AC sump pumps are strong, dependable and so energy efficient, they could pay for themselves in a few years. The sump pumps are equipped with dual float switches for added reliability. When your main AC pump needs replacement, consider upgrading to one of the pumps in the Basement Watchdog line.



FLOAT SWITCHES

What's the most common reason your main AC pump fails?

It's probably the result of a float switch that is stuck or broken. Replace it with a Basement Watchdog dual float and controller for reliable operation. The dual float has, not one, but two floats mounted within a protective cage. Should one float fail to operate, the second float automatically activates the pump. The protective cage prevents debris or other wires from interfering with the movement of the float. It can be used to replace the float on most AC pumps.



CHECK VALVES

What's a Klunkless Check Valve™?

If you've spent any time in your basement, you've probably noticed your sump pump turning on and off with a loud clunk. That's the result of the water pressure slamming the valve closed in the check valve. The Klunkless Check Valve has a built-in air chamber to counteract that pressure and muffle the sound. It works just like a conventional check valve, only quieter.



WATER ALARMS

Minimize the risk of water damage

You can detect leaks before they become bigger problems by placing a water alarm wherever there is a risk of water damage...in the utility room, laundry room, kitchen, bathroom or basement. The alarm will sound when as little as 1/32" of water reaches the sensor.



